



stretch hooders

**Willems**  
baling equipment

Stay in or go out?

We protect ourselves against almost everything, indoors and on the move.

Who can protect your goods during their journey and make sure they arrive in perfect condition?

No matter what.

Willems Stretch Hooding is the answer to that question.

Dust, rain or shine

**Permium Protection. Always.**



- 02 | 03 protection
- 04 | 09 stretch hooding techniques
- 10 | 25 stretch hooders
- 26 | 29 Willems (since 1992)
- 30 | 31 product range

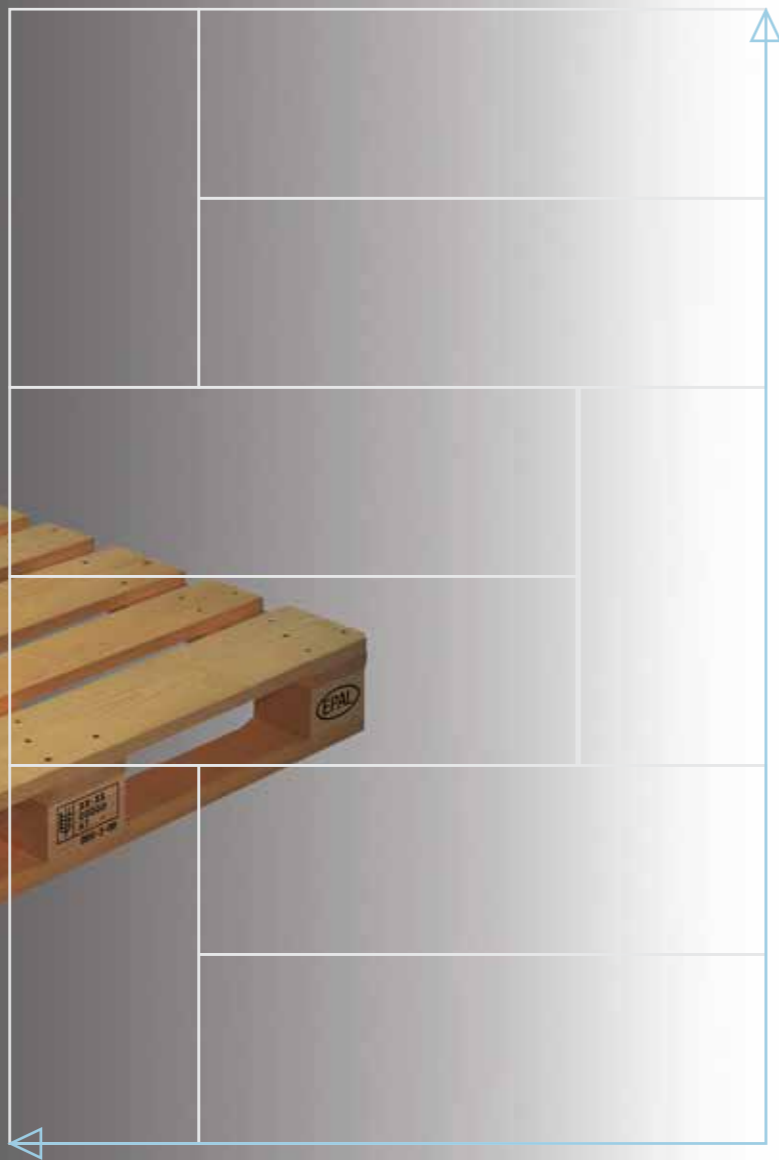

Stretch Hooding technology is an excellent alternative to traditional shrink or stretch wrapping systems. It offers increased load stability, complete weather protection, reduction in packaging material costs and labor savings. As a leading manufacturer of state-of-the-art packaging machines, Willems created a high quality and efficient solution for pallet stabilisation; the Stretch Hood machine. We offer the highest protection for pallet loads. To ensure minimum film usage and the best stability, our stretch hooders use vertical stretching forces to increase the load stability significantly; an innovative and unique packaging method.



Full protection against dirt, dust and moisture, scratches and surface damages. Our unique stretch hood pallet wrapping machine produces secured pallet loads that are perfectly suitable for outside storage and transport.



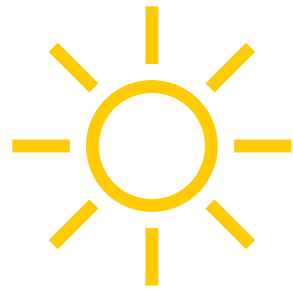

Protection against sun and UV radiation



Protects against rainy and windy conditions



Theft protection

### UNIQUE SPECIFICATIONS



Dust and dirt



No instability



Protection against snow



No damage

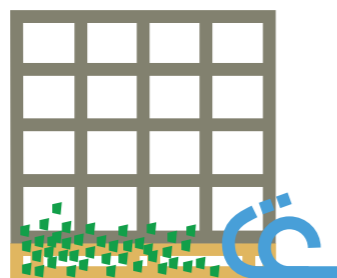

No moist, pollution and splashing water



And... printable logo on film



Willems is a **leading manufacturer** of state-of-the-art packaging machines.

Because we build the machines in-house, we offer enormous flexibility and excellent quality control.

Our production is fitted with the finest equipment, which allows them to work accurately and efficiently.

We employ highly-qualified specialists and utilise extremely advanced facilities for designing, fabricating, assembling, and thoroughly testing our machines.

Our experts -with a lot of experience developing and building packaging machines- were triggered to build the ultimate stretch hood machine. They did so!

**Willems Baling Equipment** was established in 1992.

With pride we are looking back at many successes in designing and developing the ultimate packaging machines.

When the ideas of experienced engineers and creative young designers meet, special things are happening.

Together we generate a massive capacity in solving complex packaging challenges.

Every day. For 25 years already.

And... the best is yet to come.



# COMPARE

- Holding strength
- Energy consumption
- Film costs per pallet
- Film reel changes
- Film consumption
- Optical properties
- Film transparency
- Product presentation
- Storage outside / waterproof
- Capacity / pallets per hour
- Printability
- Pallet diversity
- Loose film tails
- Perforated film
- Colored film
- Attraction dust / dirt
- Stability
- Machine investment
- Machine lifetime

	Stretch Hood	Schrink Hood	Stretch Wrap
Holding strength	****	***	***
Energy consumption	*****	*	*****
Film costs per pallet	****	**	*****
Film reel changes	*****	***	*
Film consumption	*****	*	*****
Optical properties	****	***	**
Film transparency	*****	*****	***
Product presentation	*****	***	***
Storage outside / waterproof	*****	*****	**
Capacity / pallets per hour	*****	***	***
Printability	*****	*****	**
Pallet diversity	*****	**	*****
Loose film tails	****	****	*
Perforated film	****	****	****
Colored film	*****	*****	*****
Attraction dust / dirt	*****	*****	****
Stability	*****	**	****
Machine investment	****	***	*****
Machine lifetime	*****	****	*****

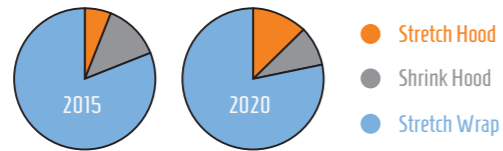

\* = acceptable  
 \*\*\* = good  
 \*\*\*\*\* = perfect

# Continuity



A reliable, fully automated production line, delivering perfect products day in, day out.  
 No worries, no problems. The optimum return on your investment.  
 Continuity, that's what really matters to be competitive and make a healthy profit.

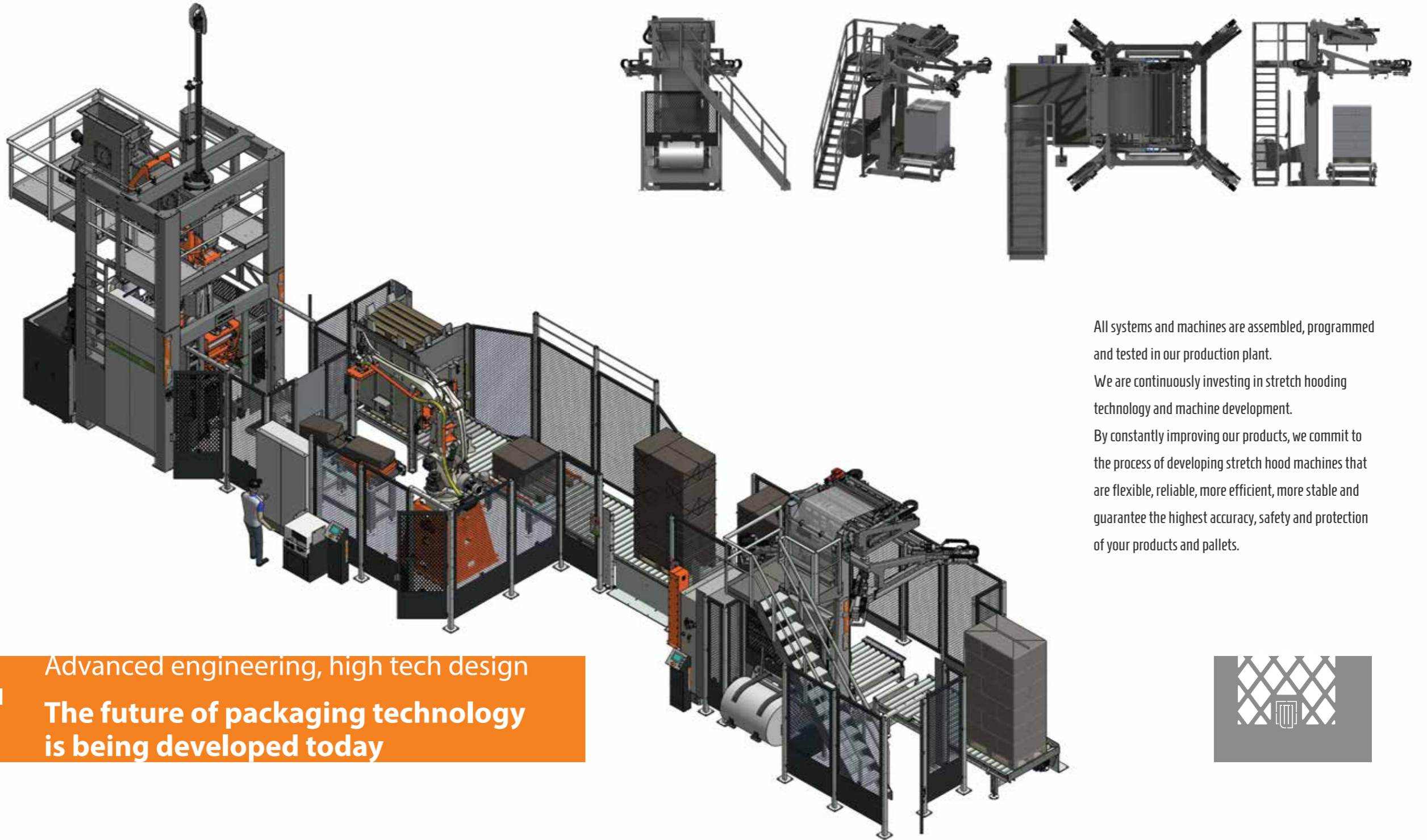
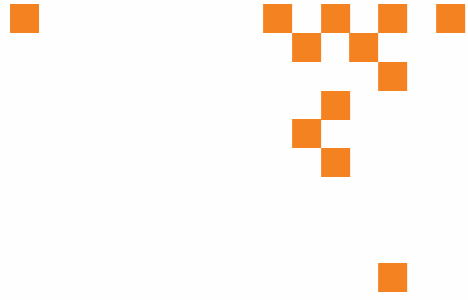

Our company manufactures innovative packaging systems for all our customers worldwide.

We have all the necessary expertise and facilities under one roof: mechanical and electrical engineering departments with state of the art 3D CAD and E-Plan software.

All systems are fully assembled, programmed and tested in our factory.

All systems and machines are assembled, programmed and tested in our production plant.

We are continuously investing in stretch hooding technology and machine development.

By constantly improving our products, we commit to the process of developing stretch hood machines that are flexible, reliable, more efficient, more stable and guarantee the highest accuracy, safety and protection of your products and pallets.



Advanced engineering, high tech design

**The future of packaging technology is being developed today**





# hooder

This very energy efficient Hooder model M can handle pallet sizes from 600 x 800 to 1,200 x 1,100 mm.



## Willems stretch hood packaging systems

### Advantages for Hooder L and Hooder M:

- Maximum pallet stability with an up-to-date stretch hood system.
- Optimal weather protection due to watertight pallet packaging. Suitable for outside storage.
- Easy access to all moving parts at floor level or on the balcony for easy maintenance and inspection.
- Solid construction and low overall height.
- Horizontal and vertical stretching of film results in an excellent load stability and reduced film costs.
- The hood can be pulled down to the bottom edge of a pallet, to secure the load/stack to the pallet.
- The stretch hood machine is suited for different film rolls. The machine-settings will change automatically to the desired roll.
- High capacity / approx. 120 pallets per hour.
- No loose film ends.
- Minimum film reel changes.
- Easy label scanning due to high transparency foil.

# hooder

Stretch Hooder model L handles pallet sizes from 600 x 800 until 1,600 x 1,200 mm.

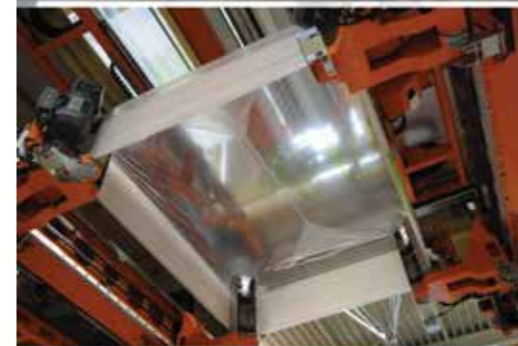

## Specs

		
Series	Medium 1800 / 2400 / 3000	Large 2400 / 3500
Pallet dimensions	from 600 x 800mm to 1,200 x 1,100mm	from 600 x 800mm to 1,600 x 1,200mm
Load height	min. 250mm - max. 3,000mm * (incl. pallet)	min. 250mm - max. 3,500mm * (incl. pallet)
Load dimensions	max. 1,300 x 1,100mm	max. 1,750 x 1,350mm
Load tolerance	offset max. 50mm	offset max. 75mm
Maximum load	1,500Kg (standard)	1,500Kg (standard)
Capacity	up to 120 pallets per hour *	up to 80 pallets per hour *
Transport height	500mm - 600mm (standard 600mm)	500mm - 600mm (standard 600mm)
Transport speed	12mtr./min.	12mtr./min.
Power supply	3x 400V, 50Hz + Earth + "0"	3x 400V, 50Hz + Earth + "0"
Installed power	9.6 KW	14 KW
Diameter film reel	max. 1,000mm	max. 1,000mm
Required floor space	approx. 3,050 x 4,150 x 3,750mm* (LxWxH)	approx. 3,400 x 4,930 x 4,390mm* (LxWxH)

\* depending on Series



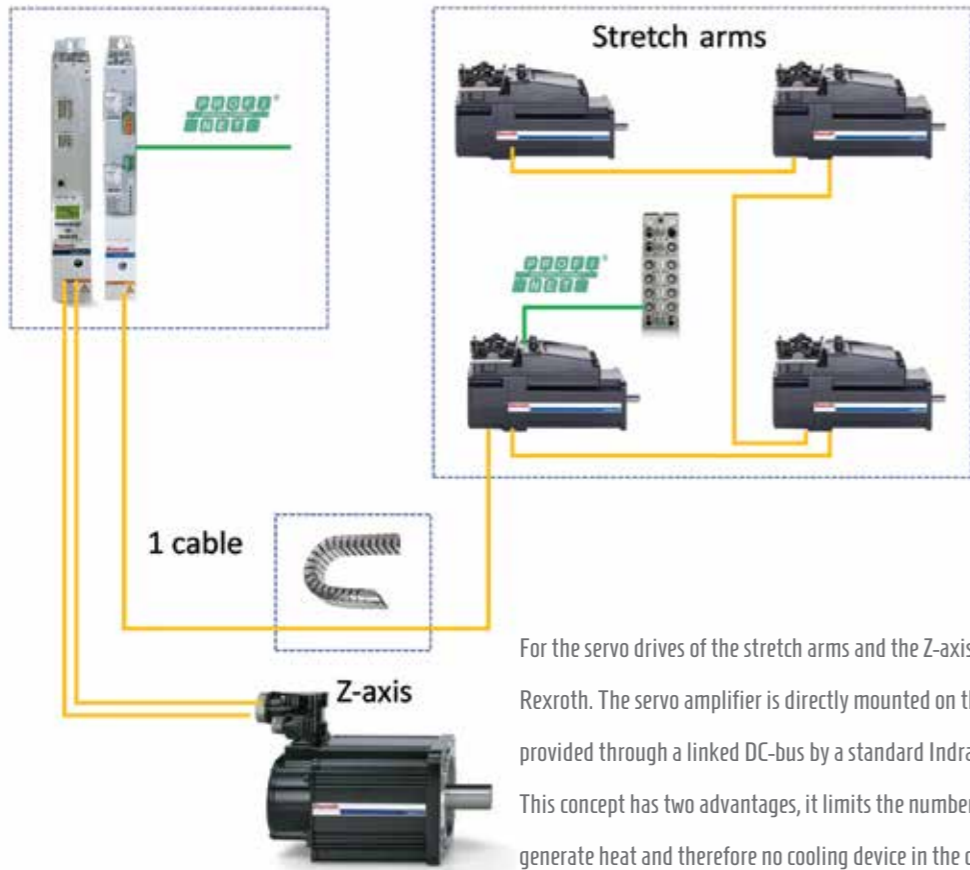

**Rexroth**  
Bosch Group

**SIEMENS**

**SEW**  
EURODRIVE

**Willems**

For the servo drives of the stretch arms and the Z-axis is chosen for IndraDrive Mi of Bosch Rexroth. The servo amplifier is directly mounted on the stretch motor, the power supply is provided through a linked DC-bus by a standard Indra drive, which powers the tilt movement. This concept has two advantages, it limits the number of components in the control cabinet that generate heat and therefore no cooling device in the control cabinet is necessary. By the linked DC-bus between the stretch motors and drives of the Z-axis mutual energy. During the downward movement of the Z-axis, the braking energy is released directly to the stretch arm motors. These two properties makes that the drive energy consumption of the Stretch Hood is low.



The Indradrive Mi drives an electromechanical cylinder EMC of Bosch Rexroth.

The heart of the EMC is formed by a ball screw. With this advanced control technology can even at high forces, position and speed be flexibly matched to pallet, load and stretch hood foil. Due to their perfect finish features EMC cylinders allow pollution, by a smart maintenance concept, to a minimum.

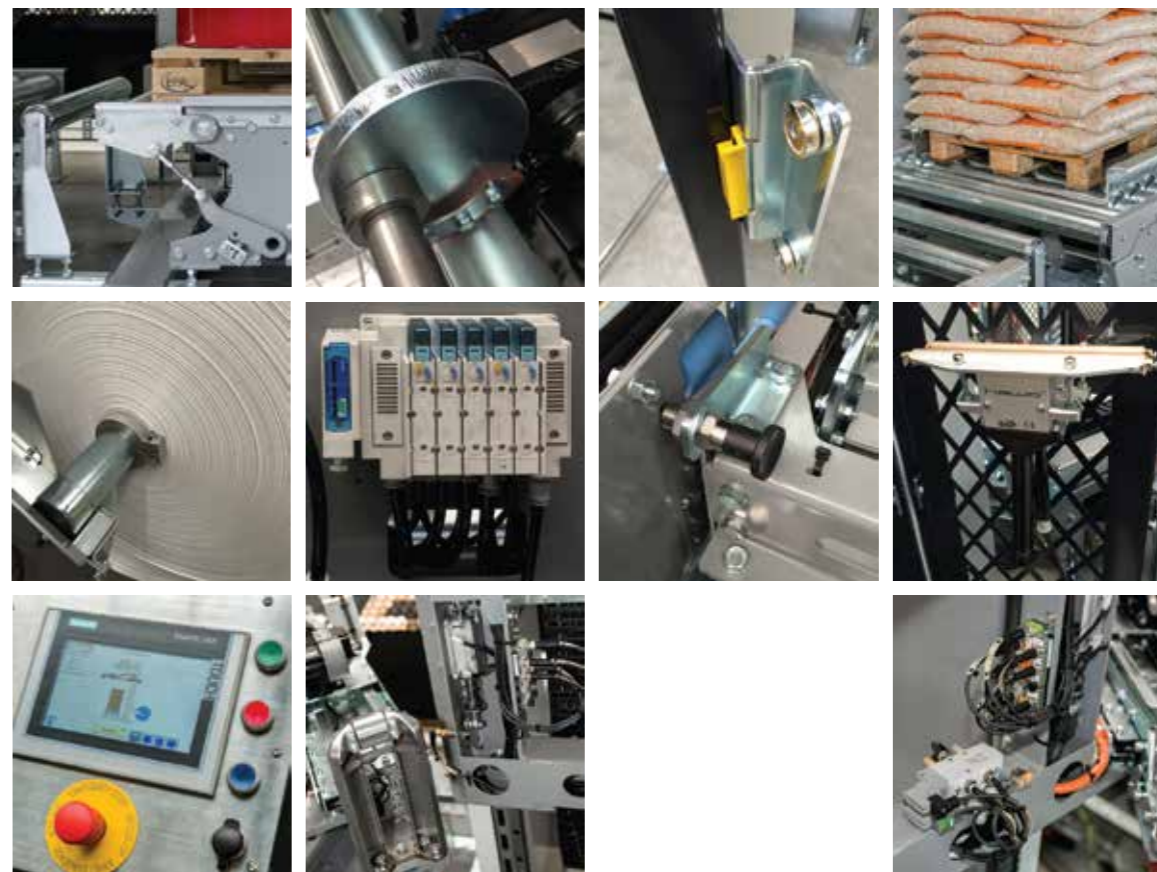

**Clever design**  
smart in every small part

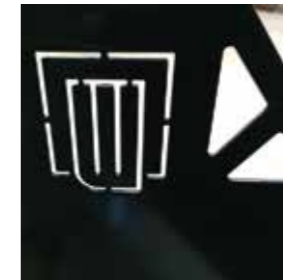

# stretcher TS



## packing bricks on pallets

Bricks are packed on a pallet with foil wrapping, top sheet and straps. The total foil consists of a round foil and a top sheet in excess that is stretched with a wrapping band around. This creates a solid unit with distinct advantages for the presentation and use.

Because of the transparent top sheet, the structure, colour and lay pattern of the bricks can be seen at a glance. The wrapping band can also be printed with logos and information for an appealing presentation. But more important: this way of packaging makes the bricks more ease of use; a total brick layer can be simply mechanically grabbed so that direct laying becomes possible. A clever solution from Willems.

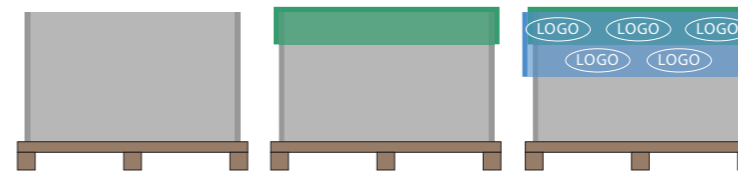

1 roundfoil wrapping

2 oversize top sheet

3 wrapping band



## bundling machine



## insulation material

Packaging insulation sheets requires a special technique. Willems created a bundling machine that produces wide wrapping bands of transparent film. Wrapping the sheets with this creates a tight and stable whole. The wrapping straps can even be printed for prominent advertising and presentation.



# Spare parts Maintenance After sales Responsible partner Teleservice

Willems builds robust machines to last for long. All integrated systems and electronics meet the highest standards so reliability is guaranteed. Our involvement does not stop when the system has been sold. Willems feels responsible for trouble free operation of the total production line, 24/7. Via built-in modems in machines, we can monitor data online and any malfunctions can be cured or even prevented from a distance. If necessary, we ensure that experienced specialists are available at your location to keep your production line in good condition. Everywhere, worldwide.





### Stretch Hood film



Polyethylene is a very friendly material for the environment. For the world production, only 1% of the total production of natural oil and natural gas is used.

The production is clean and efficient: the expulsion of dangerous substances is minimal.

By refining crude oil or gas, ethylene is obtained.

This ethylene gas can be polymerised to plastic. After polymerisation we obtain the product polyethylene. Polyethylene film is produced by melting granulates of polyethylene at about 200°C and pressing them together with compressed air through a circle matrix.

The material then rises up like a balloon of plastic film.

After cooling, rollers squeeze the film in a double layer, after which it is rolled up and ready for further processing.

To add extra properties to the film, we can add additives to the material while extruding. Typical used properties are: colouring of films, removing static electricity, blocking of UV radiation, regulating the coefficient of friction, etc.

Polyethylene is extremely suitable for recycling: it can be melted and re-used indefinitely. When it can't be re-used, it is an eminent fuel for energy provision.



**Quality** In manufacturing, a measure of excellence or a state of being free from defects, deficiencies and significant variations. It is brought about by strict and consistent commitment to certain standards that achieve uniformity of a product in order to satisfy specific customer or user requirements. ISO standard defines quality as “the totality of features and characteristics of a product or service that bears its ability to satisfy stated or implied needs.”

**Reliability** 1. The ability of an apparatus, machine, or system to consistently perform its intended or required function or mission, on demand and without degradation or failure.  
2. Manufacturing: The probability of failure-free performance over an item's useful life, or a specified timeframe, under specified environmental and duty-cycle conditions.

**Efficiency** The comparison of what is actually produced or performed with what can be achieved with the same consumption of resources (money, time, labour, etc.). It is an important factor in determination of productivity.



Willem's was established in 1992 and has become one of the leading brands; a global standard for innovation, efficiency and quality.

Our company manufactures smart packaging systems for customers worldwide.

We are investing in new technologies and machine development. We work on technology to make our machines even safer, more efficient, more precise, faster and more flexible. Every day.

By constantly improving our products, we produce solid and reliable machines and guarantee the highest accuracy, safety and protection.

Cost-effective solutions for a broad range of pallet stabilisation and transport packaging needs.

Our own specialists are responsible for the complete process; from design, production, testing, and transport, all the way to installing, adjusting and start-up the machine on location.





# Engineering



# Assembly



# Manufacturing



# Automation

# Product range

Willems offers total solutions for compressed packaging of bulky products; high quality machines for sorting, compressing, weighing, packaging and palletising. All of them easy to integrate into your production line.

## log shavers

Transport and processing of logs

Our systems for cross- and long-haul transport supply via step feeders the debarker and log shaver.

Log shavers are equipped with advanced interchangeable blade cassette for optimised production.

## bulk handling and storage

Not only the machines, but the entire logistics of production can be delivered by Willems turnkey.

Screens, transportation and storage systems belong to this. **Drum screen** for separation in two formats; small parts fall through the screen, large parts remain.

**Star screen** to remove large parts from the product too. **Shake screen** separates the product in different roughnesses: A / B / too large parts. **Airscreen** for product-specific applications.

Chain conveyors, infeed systems and redlers  
Horizontal and conductive screws with various

dimensions and capacities, depending on the product.

**Stationary and conveying floor bunkers** or bunkers with screws for storage are being produced to the clients specifications.

## balers

Willems supplies horizontal and vertical balers for compressed packaging of various products.

Depending on your wishes, our presses produce bales with weights between 1 and 1500 kg.

**Products:** Alfalfa, bark, cellulose fibres, flax, fiber-glass, glass wool, grass, hay or straw, hemp fibre, insulation material, corn, mulch, nylon fibres, paper pulp, potting soil, compost soil, pulp fibres, sawdust, short dusty fibres, silage, substrates, synthetic fibres, peat, wood chips, wood shavings, etc...

**Bundling machines** for merging small packages.

The machine collects products, packs two pieces of foil on roll and draws the film over the formatted products.

**Form filling machine** for pellets and other release products. Capacity: Depending on product specifications tailored to customer requirements.

**FFS machines (Form Fill Seal)** for the disposal of bulk products.

## robots

Our high end **robot palletising systems** can be easily adjusted to requested, constantly changing product specifications and sizes. For example for stacking bags, bales or barrels.

## pallet packaging machines

Our experience in designing and building high-quality packaging systems led to **the ultimate stretch hooder machines**. These offer an excellent solution for a large number of pallet packaging needs during storage and transportation.

We develop logical software for **intuitive operation** via a touch screen on which complex systems, mechanical processes and movements in the machine are being visualised.

**Online Teleservice Monitoring (OTM)** allows us to analyse machine data remotely. Possible problems can be cured (or even prevented) using our online remedies. OTM is our advanced diagnostic system in which potential malfunctions are defined for all machines. Anywhere in the world.

# Product brochures

## Log shavers

- Tree transport, cross and along
- Singulator, stepfeeder, debarker
- Log shavers

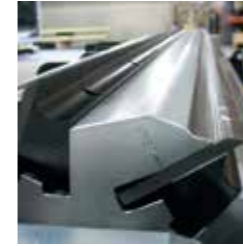

## Bulk handling and storage

- Stationary and conveying floor bunkers
- Chain conveyors, infeed systems, redlers and air transport
- Screens
- Truck loading- and unloading systems



## Baling equipment

- Balers
- Flatfoil machines
- Lowering machines
- Bundling machines



## Robots

- Robot palletising systems
- Product handling and transport
- Pallet transport



## Pallet packaging machines

- Stretch hooders
- Bricks packaging machines
- Insulation sheets bundling machines





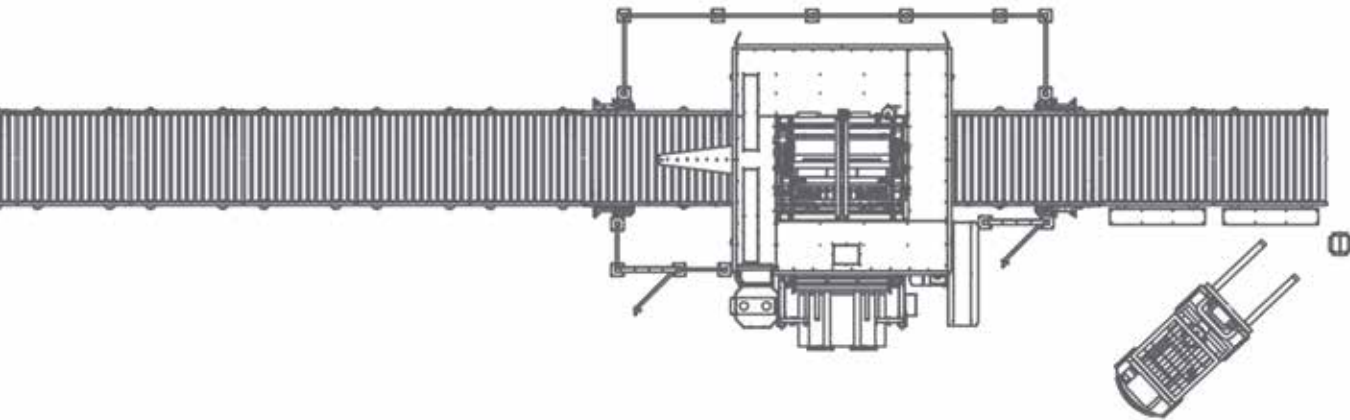

top quality from The Netherlands



**Willems Baling Equipment bv**

Hallenstraat 12d

5531AB Bladel The Netherlands

T +31(0)497.64 40 55

E [wbe@willemsbaling.eu](mailto:wbe@willemsbaling.eu)

W [willemsonline.com](http://willemsonline.com)



graphic design [copart.nl](http://copart.nl)



B5.2017.08.E